

2301 E. Vernon Ave.
Vernon, CA 90058
866.443.7258
323.908.5430

7601 Ambassador Row
Suite 102
Dallas, TX 75247
214.295.2165

7505 Bluff Point Dr.
Suite 100
Houston, TX 77086
713.405.3353

110 Viaduct Rd
Stamford, CT 06907
203.316.8033

www.wilsonpart.com

DEMOUNTABLE - SERIES 225

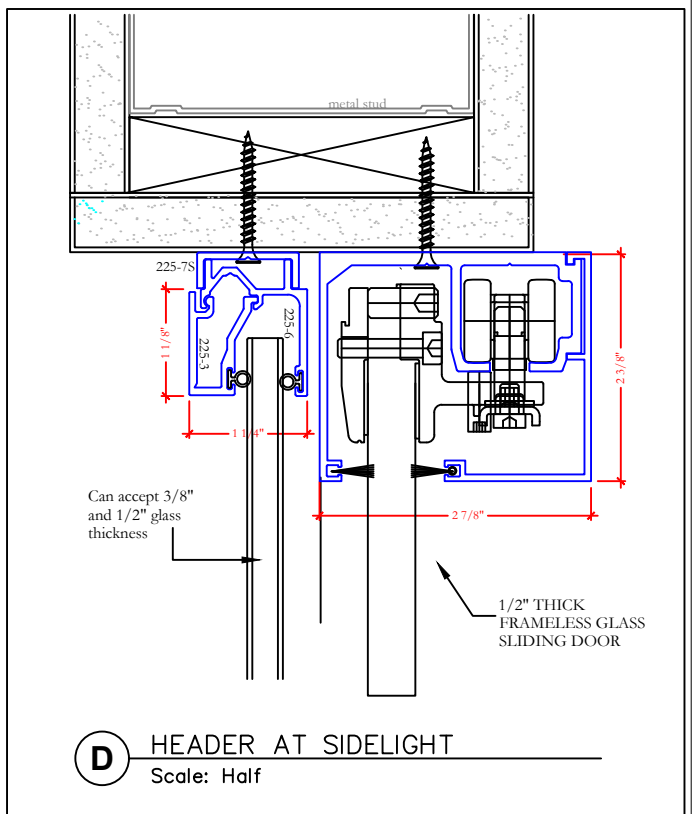
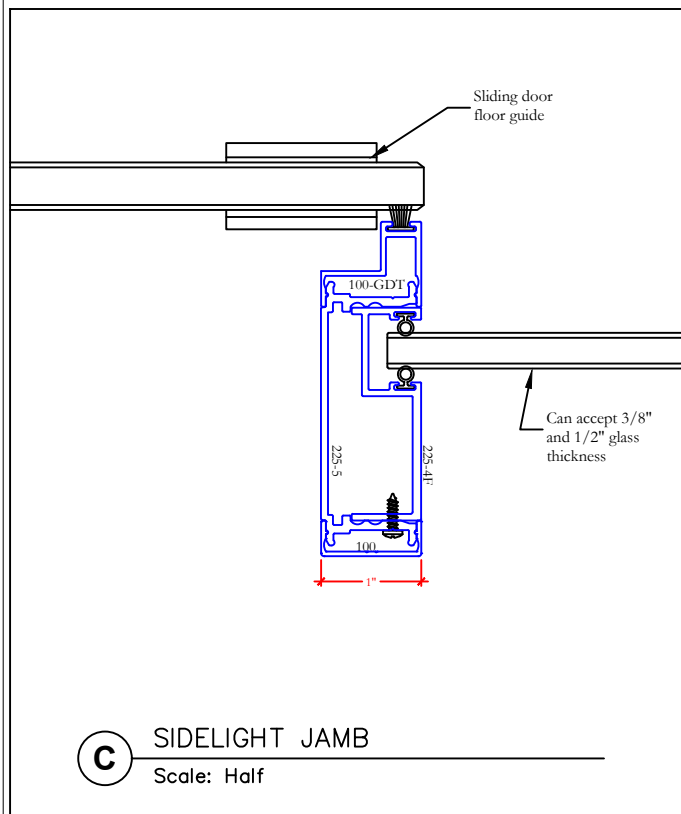
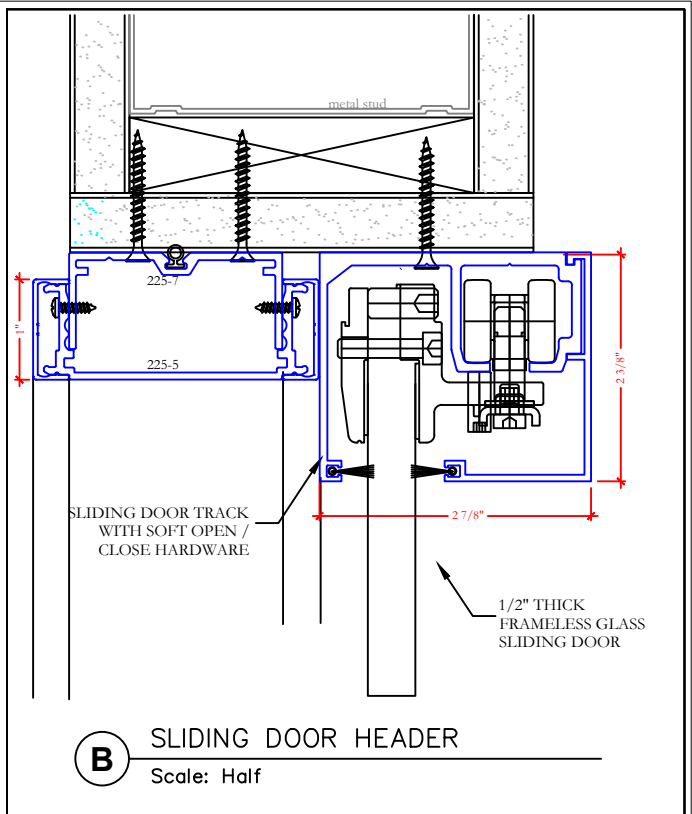
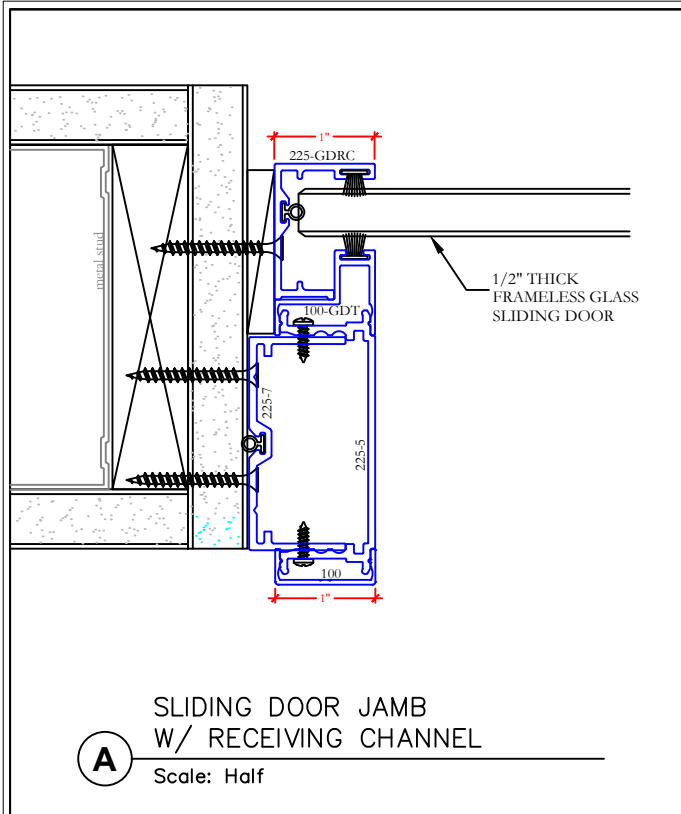

2301 E. Vernon Ave.
Vernon, CA 90058
866.443.7258
323.908.5430

7601 Ambassador Row
Suite 102
Dallas, TX 75247
214.295.2165

7505 Bluff Point Dr.
Suite 100
Houston, TX 77086
713.405.3353

110 Viaduct Rd
Stamford, CT 06907
203.316.8033

www.wilsonpart.com

DEMOUNTABLE - SERIES 225

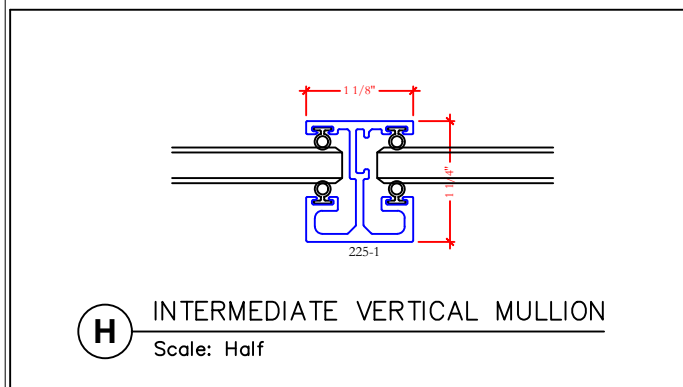
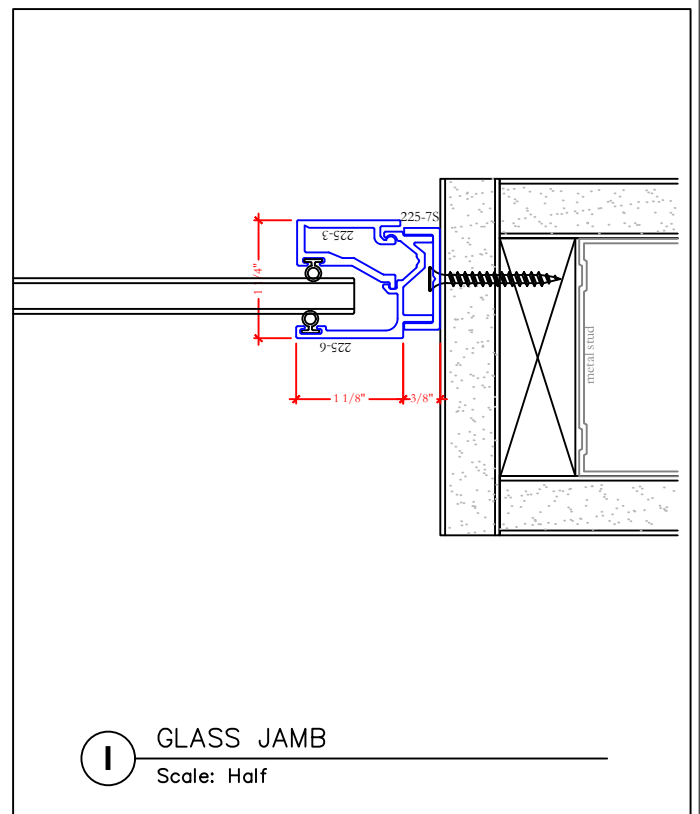
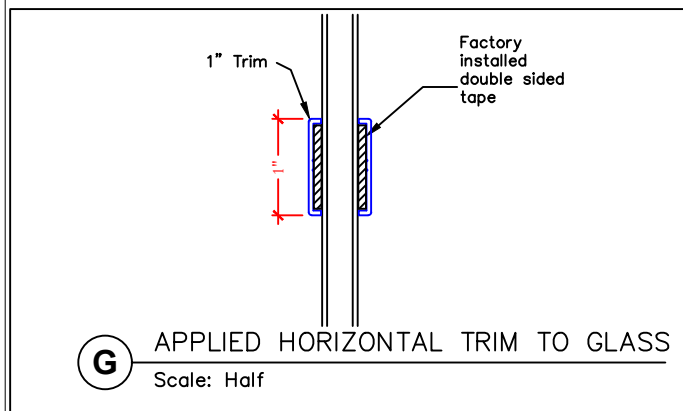
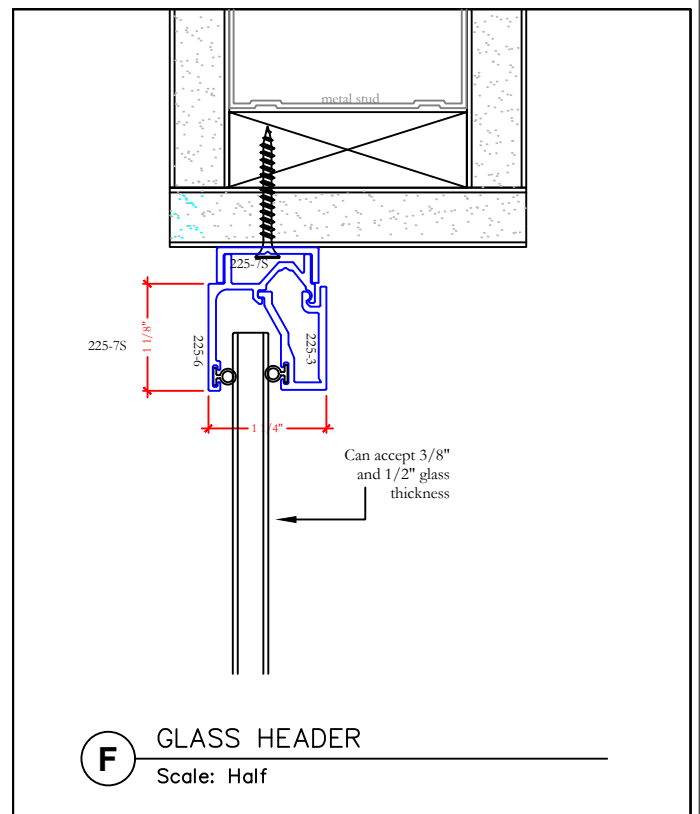
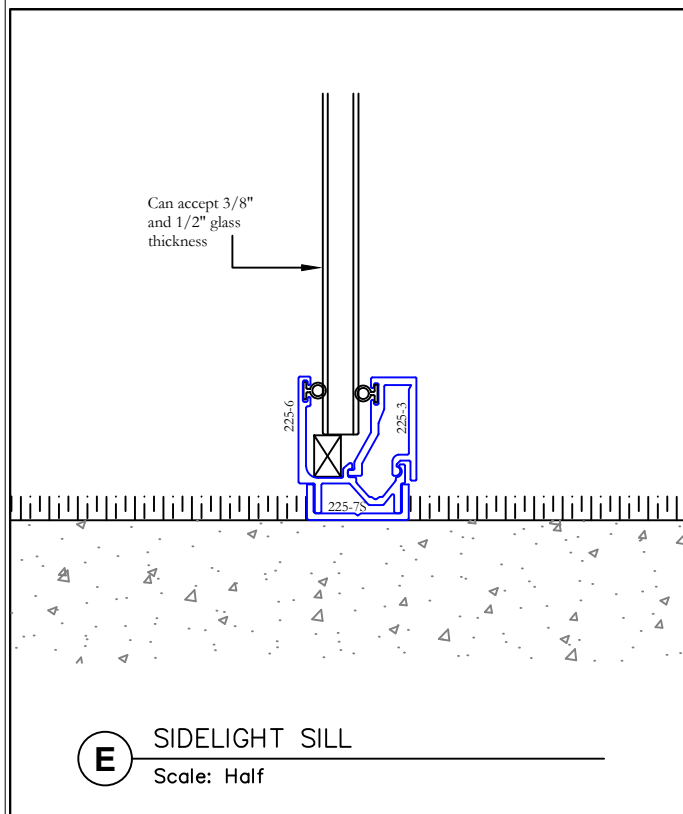

2301 E. Vernon Ave.
Vernon, CA 90058
866.443.7258
323.908.5430

7601 Ambassador Row
Suite 102
Dallas, TX 75247
214.295.2165

7505 Bluff Point Dr.
Suite 100
Houston, TX 77086
713.405.3353

110 Viaduct Rd
Stamford, CT 06907
203.316.8033

www.wilsonpart.com

DEMOUNTABLE - SERIES 225

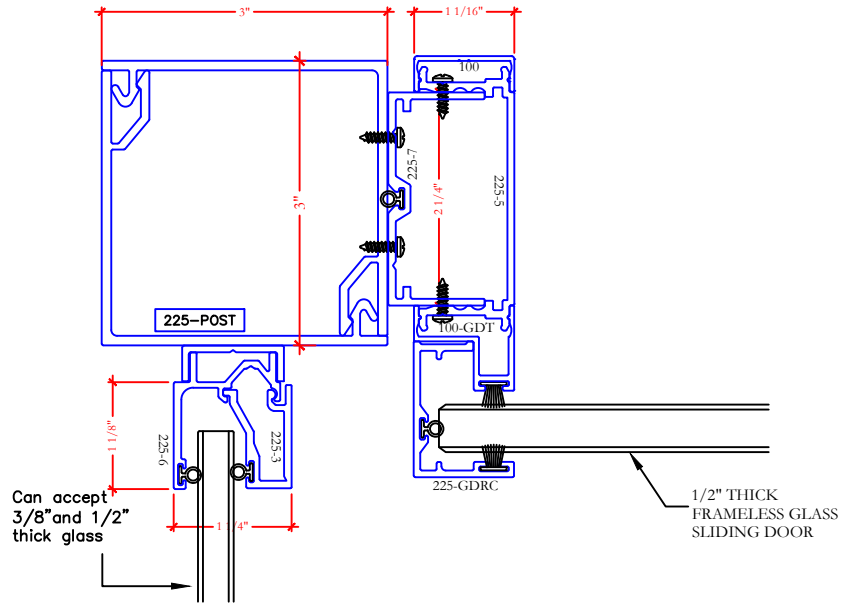

J SLIDING DOOR AT 90 DEGREE CORNER
Scale: Half

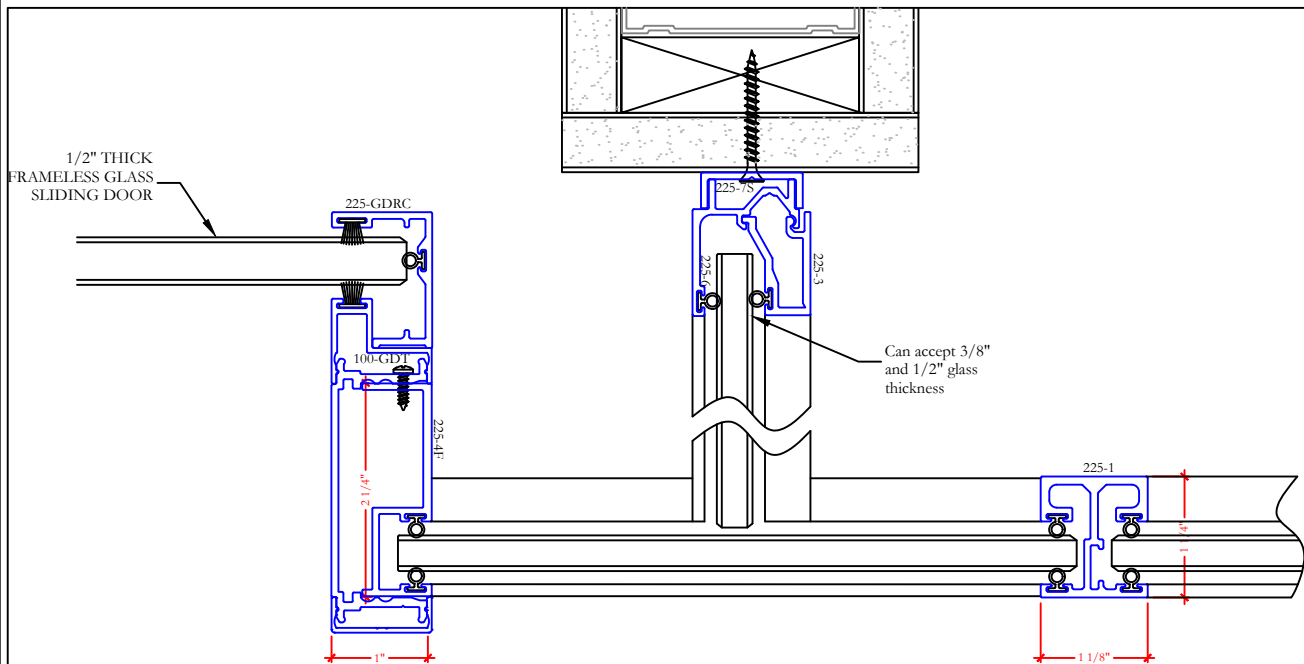

K 3-WAY BUTT JOINTED INTERSECTION
Scale: Half

2301 E. Vernon Ave.
Vernon, CA 90058
866.443.7258
323.908.5430

7601 Ambassador Row
Suite 102
Dallas, TX 75247
214.295.2165

7505 Bluff Point Dr.
Suite 100
Houston, TX 77086
713.405.3353

110 Viaduct Rd
Stamford, CT 06907
203.316.8033

www.wilsonpart.com

DEMOUNTABLE - SERIES 225

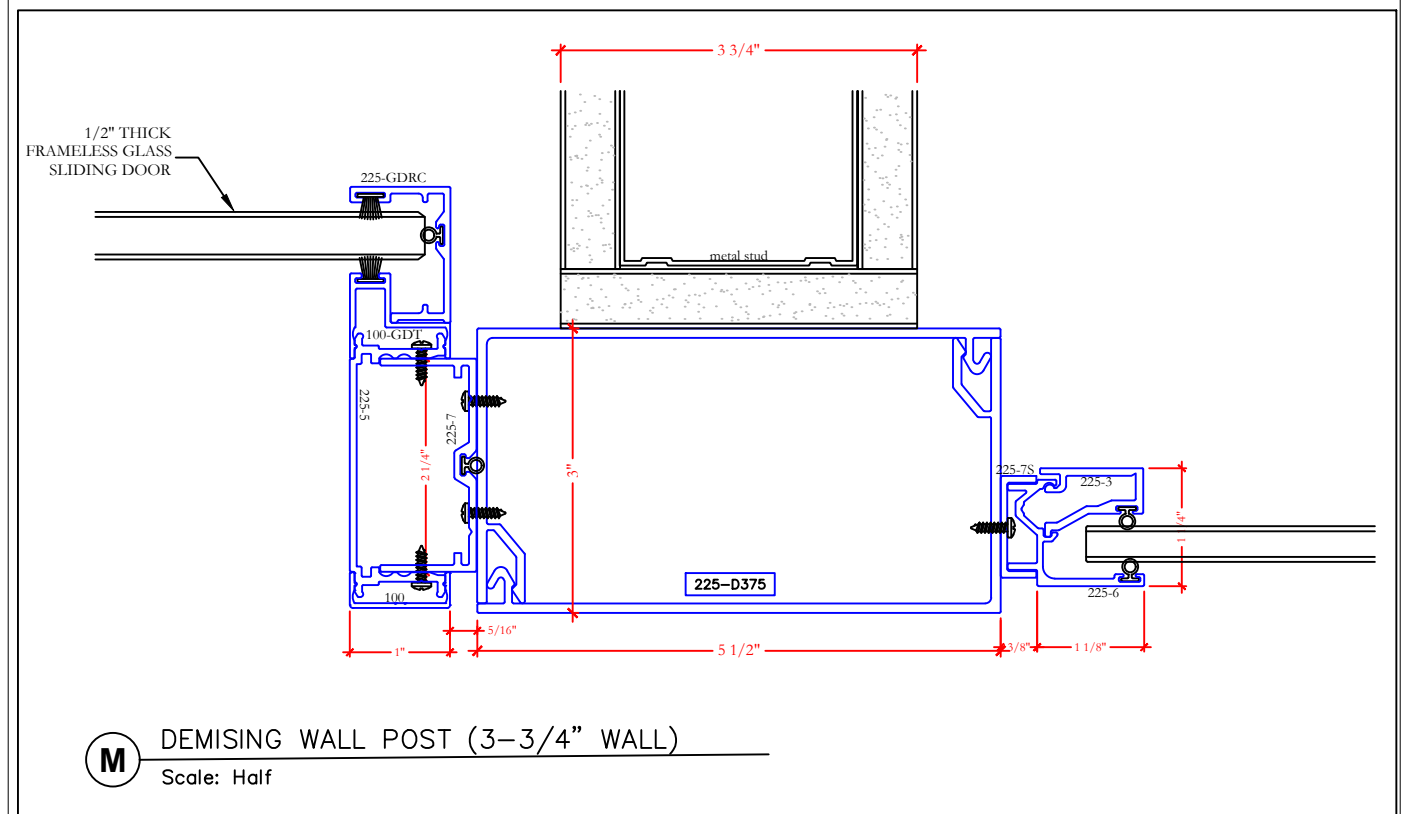
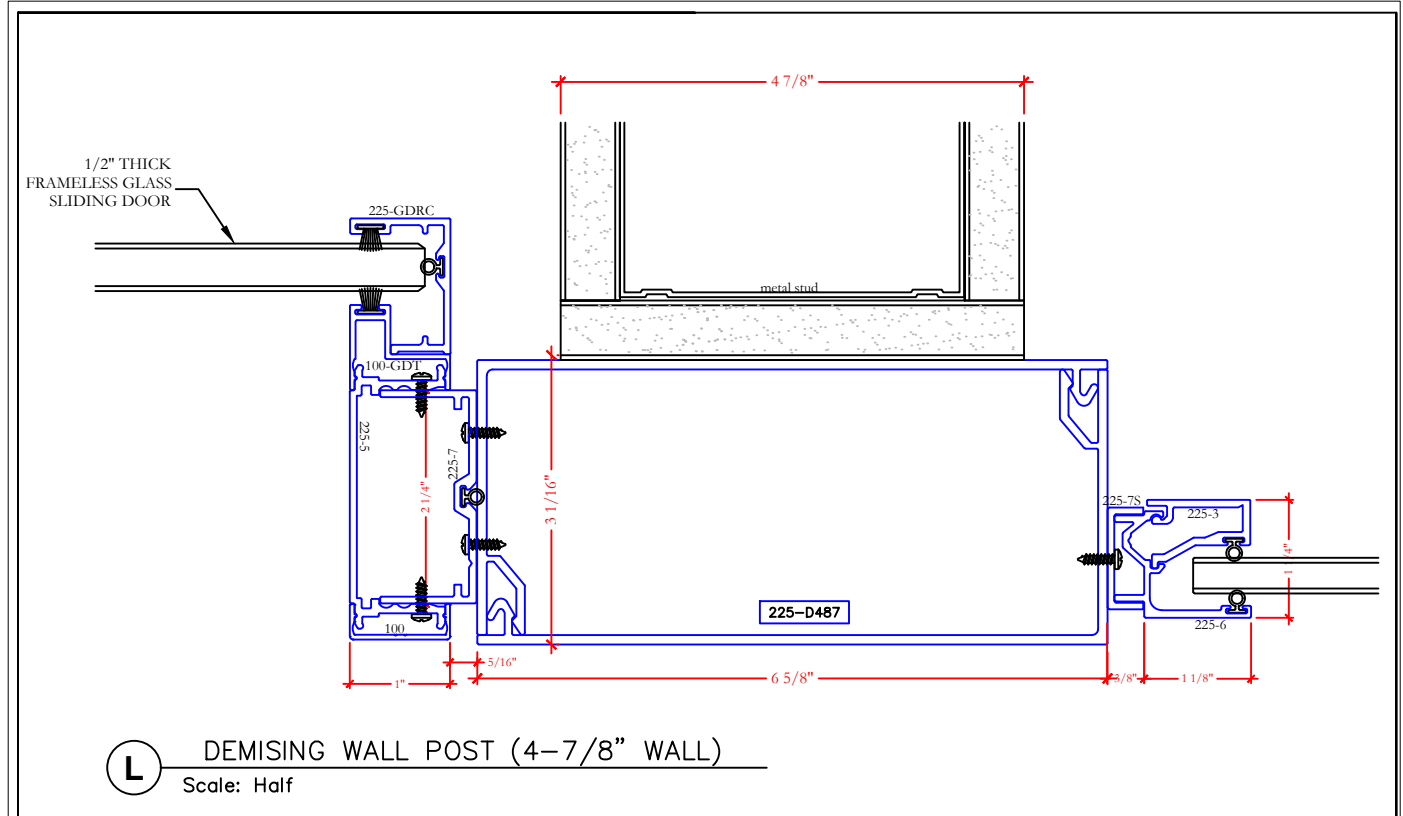

2301 E. Vernon Ave.
Vernon, CA 90058
866.443.7258
323.908.5430

7601 Ambassador Row
Suite 102
Dallas, TX 75247
214.295.2165

7505 Bluff Point Dr.
Suite 100
Houston, TX 77086
713.405.3353

110 Viaduct Rd
Stamford, CT 06907
203.316.8033

www.wilsonpart.com

DEMOUNTABLE - SERIES 225

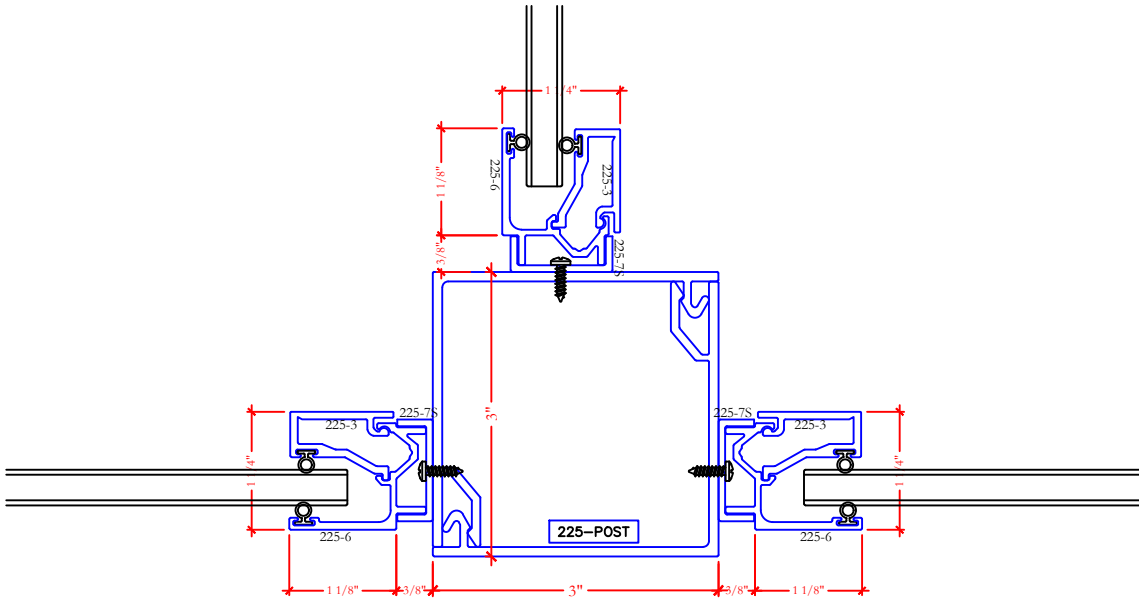

N 3-WAY POST
Scale: Half