

## Installation Instructions for Wilson Partitions 225 Demountable Wall System

### Frameless Sliding Glass Door w/ Attached Sidelight

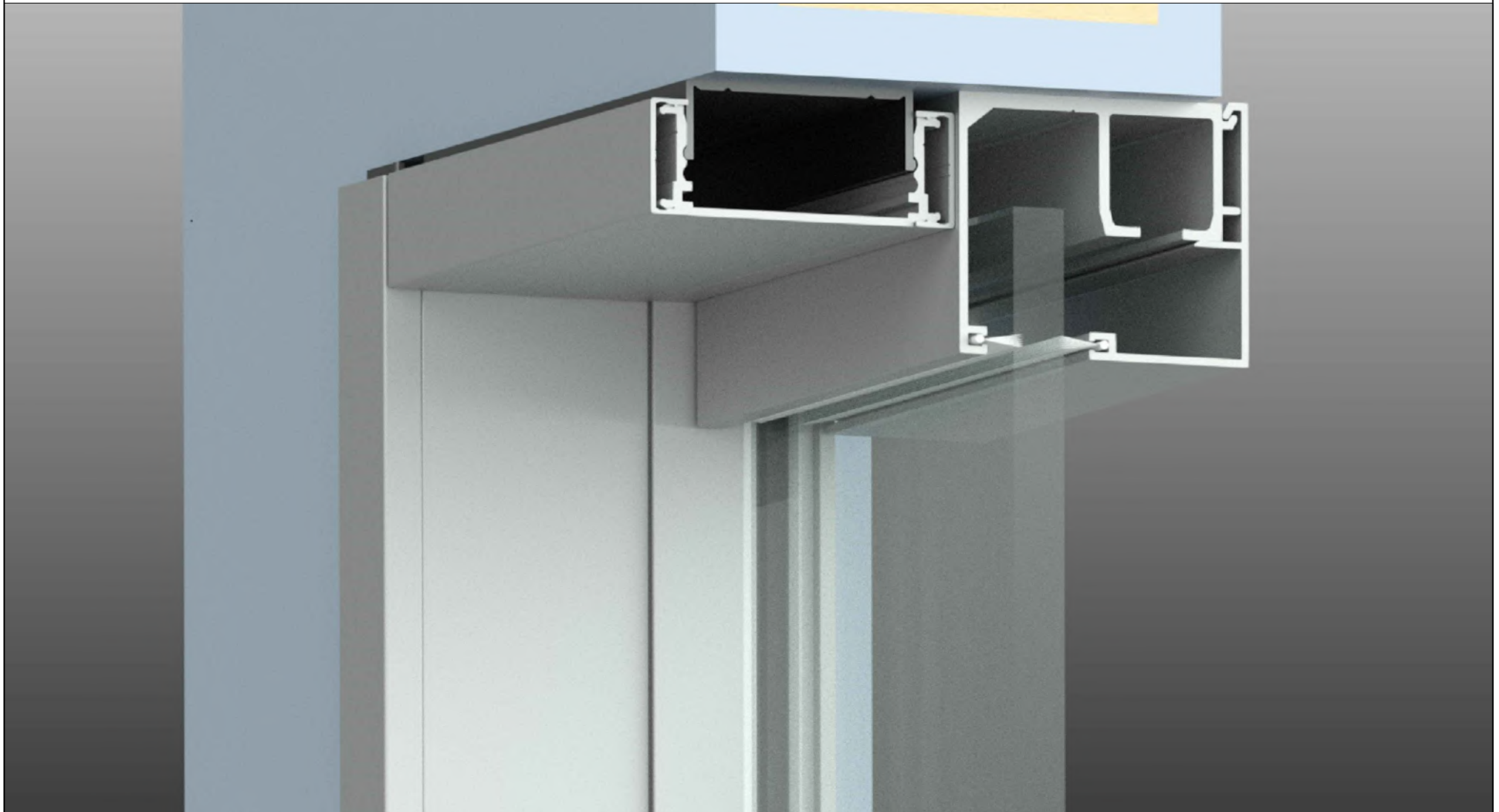

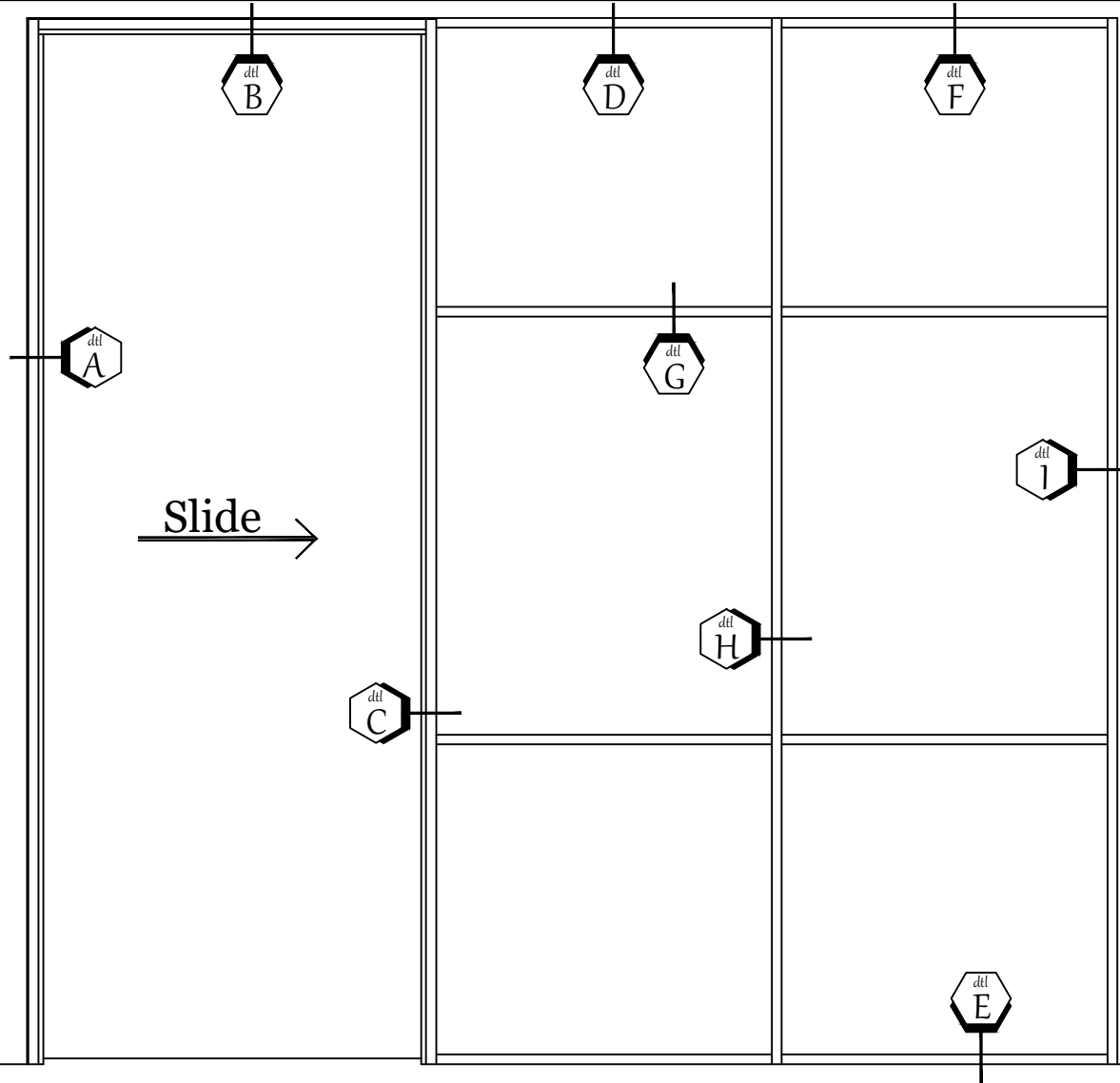



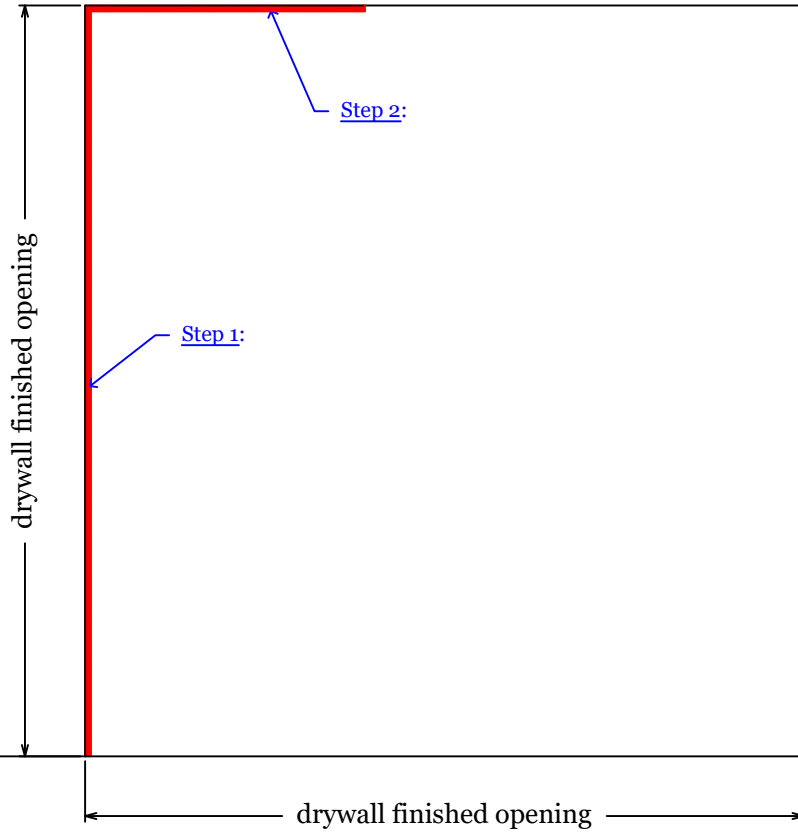

Step 1:  
Install wall start from floor to ceiling.

Step 2:  
Install the wall start above the door frame header ONLY (part is cut at the factory to the exact length - do not trim)

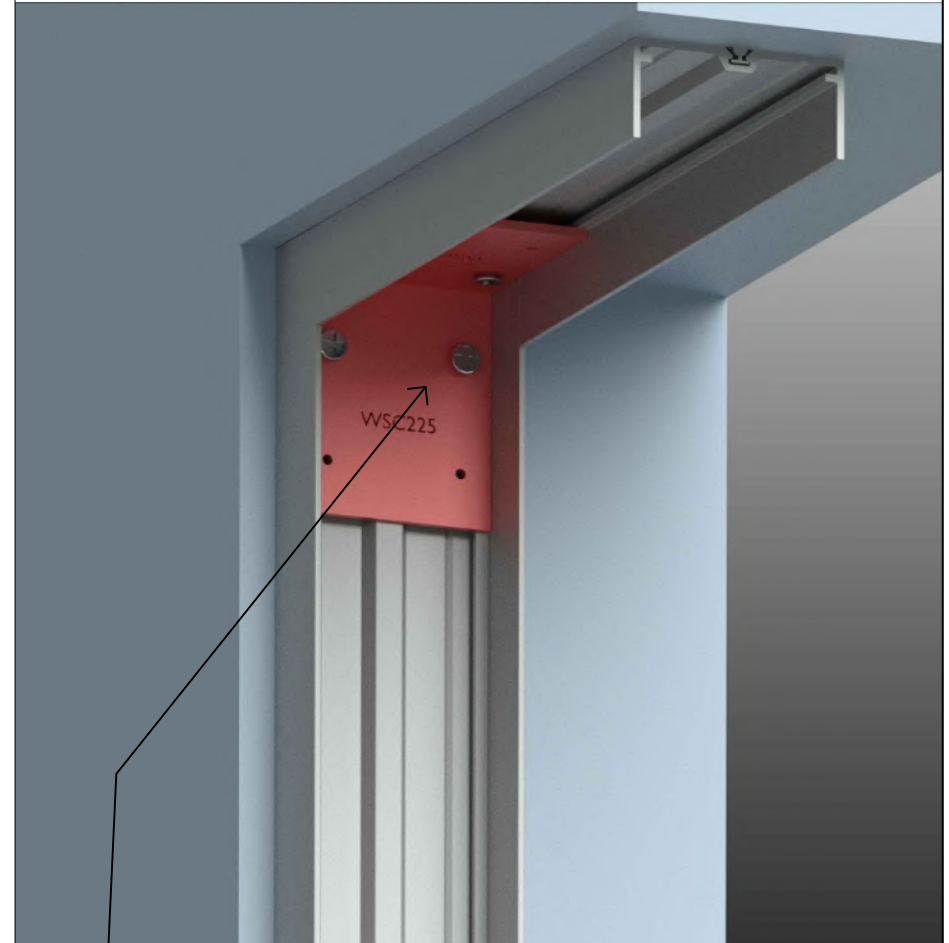

Attach wall start to drywall opening with the WSC225 clip using 1-1/4" drywall screws .... (This clip is mostly for alignment)  
Finish securing the wall start to the drywall openings using 1-1/4" drywall screws at ~ 20" o.c.

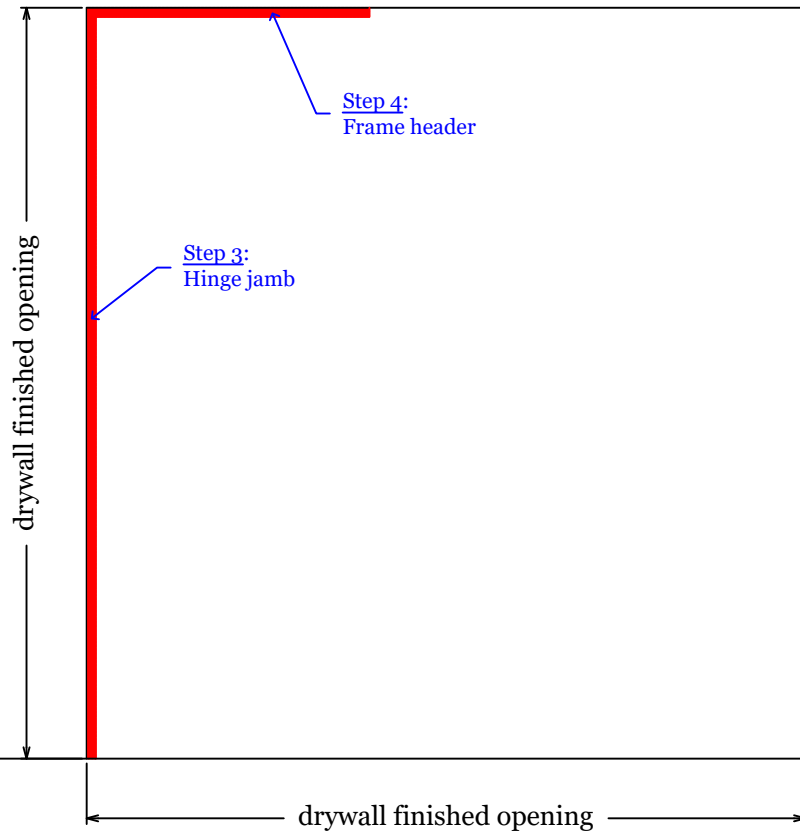

**Step 3:**  
Install the cased opening jamb over the wall start holding a  $\frac{3}{16}$ " gap.

**Step 4:**  
Install the cased opening header over the wall start holding a  $\frac{3}{16}$ " gap.  
Attached the provided CC1 corner clips on each side.

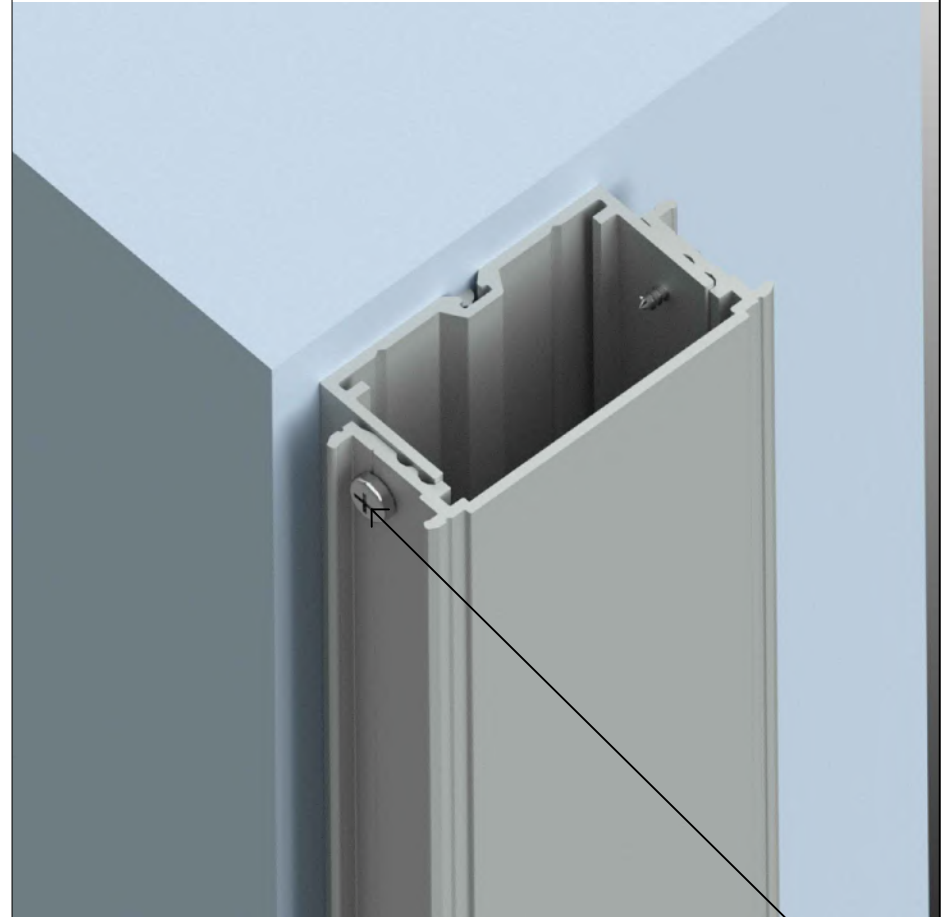

The frame at drywall locations should engage to the 1st notch ... this will hold the frame at the proper depth for trim installation

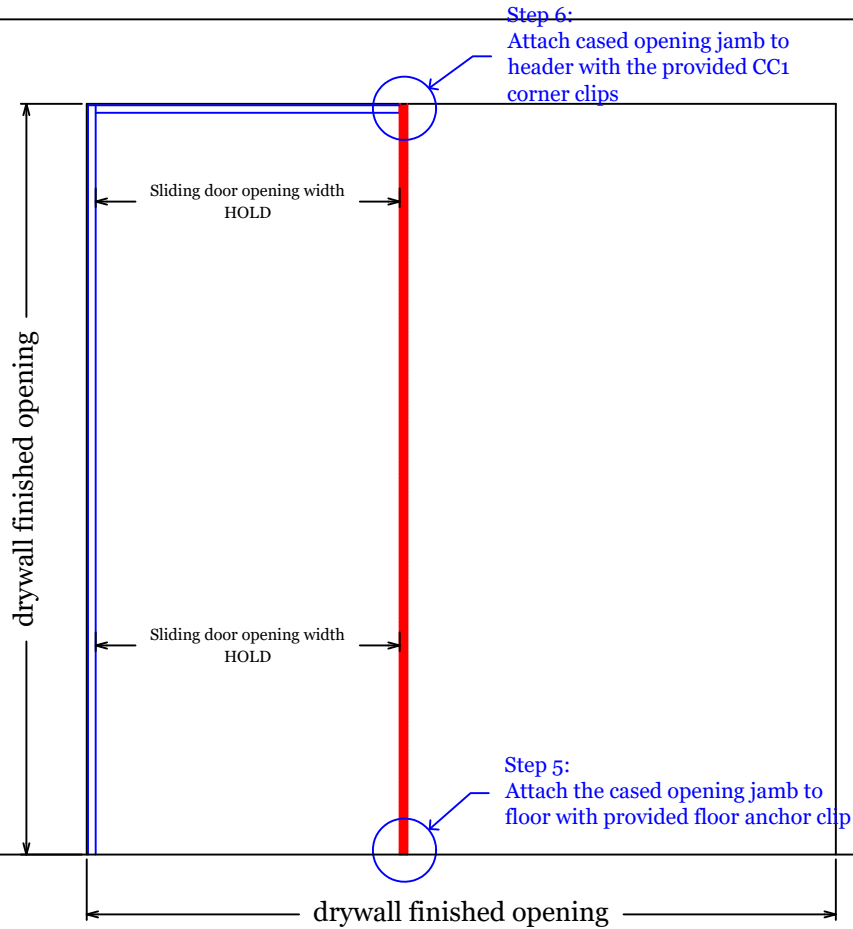

**Step 5:**  
Install the cased opening jamb using the provided 225-FC-5 floor clip ... Make sure to hold the sliding door opening width... Secure the clip to the floor using the provided anchors TapCon screws..

**Step 6:**  
Install the flush glass pocket insert into the cased opening jamb from floor to ceiling .... Keep in mind the insert will extend past the top of the cased opening jamb to the ceiling .. Attach to the header with the provided CC1 clip on each side. (NOTE: Do NOT screw on the glass pocket side of the vertical ... this will interfere with the glass installation)



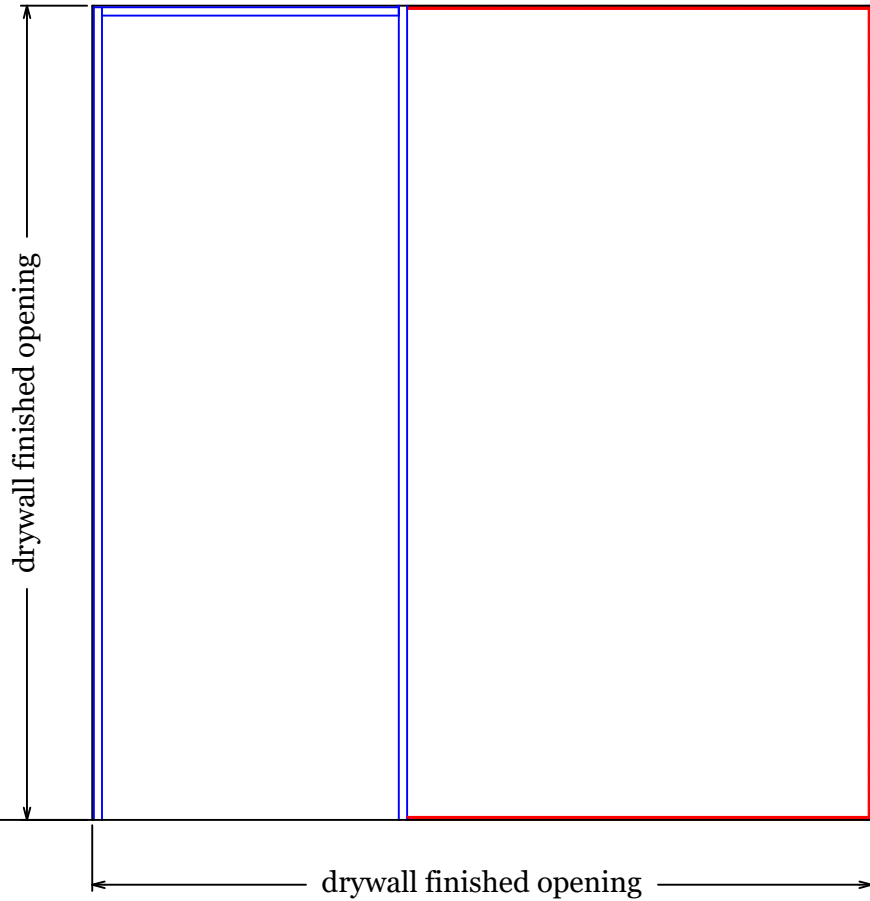

**Step 7:**

Install the small wall start (2275-7S) floor to ceiling on the opposite wall using 1-5/8" drywall screws. Proceed to install the small wall starts at the ceiling and floor. (use 1-1/4" phillips head TapCons at the floor wall start)

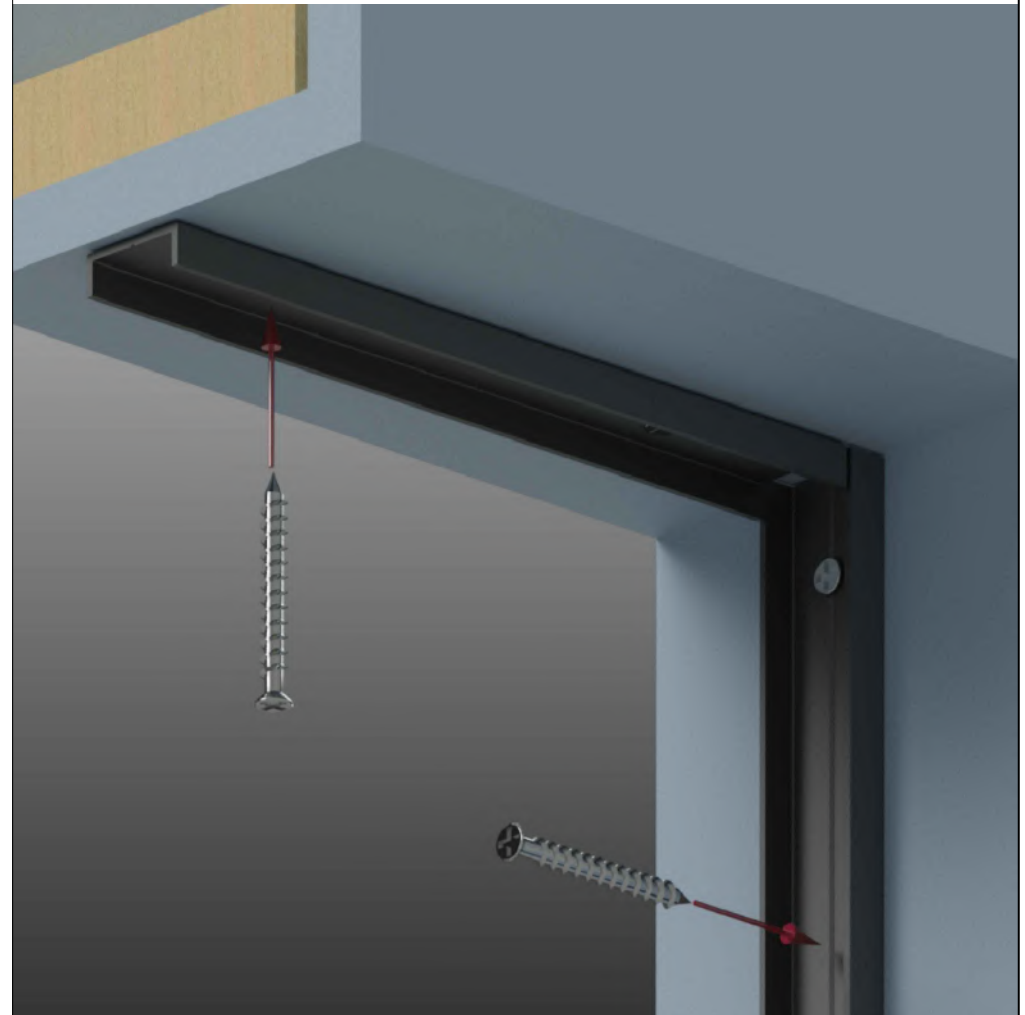



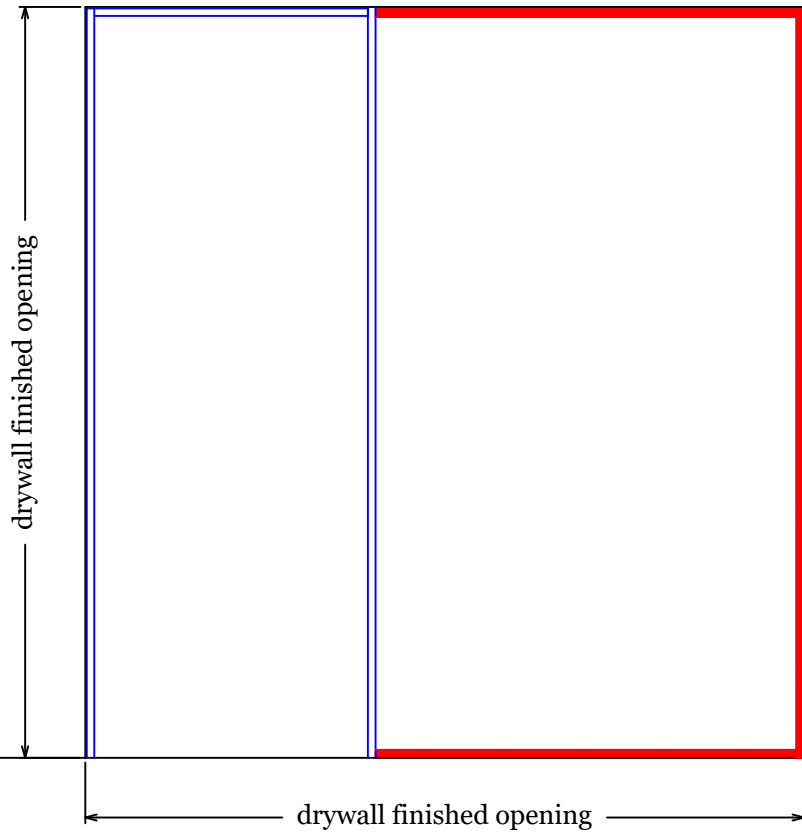

**Step 8:**

Install the 225-6 glass base on the vertical 225-7S wall start. Attached the 225-3 glass stop on the vertical 225-6.

\*\*Proceed to install the top and bottom 225-6 & 225-3.

(\*\*IF there are vertical intermediate mullions skip to step 8-INT)

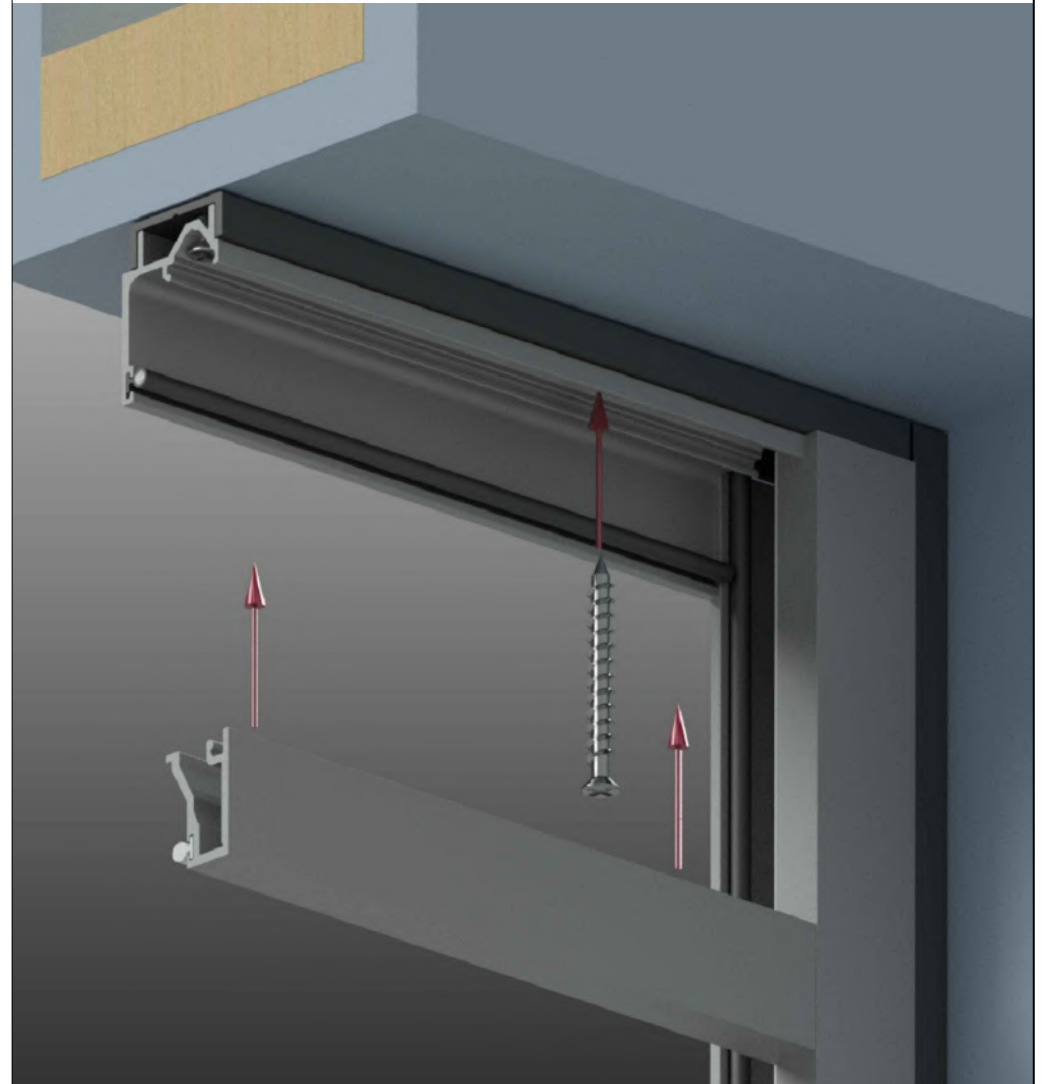



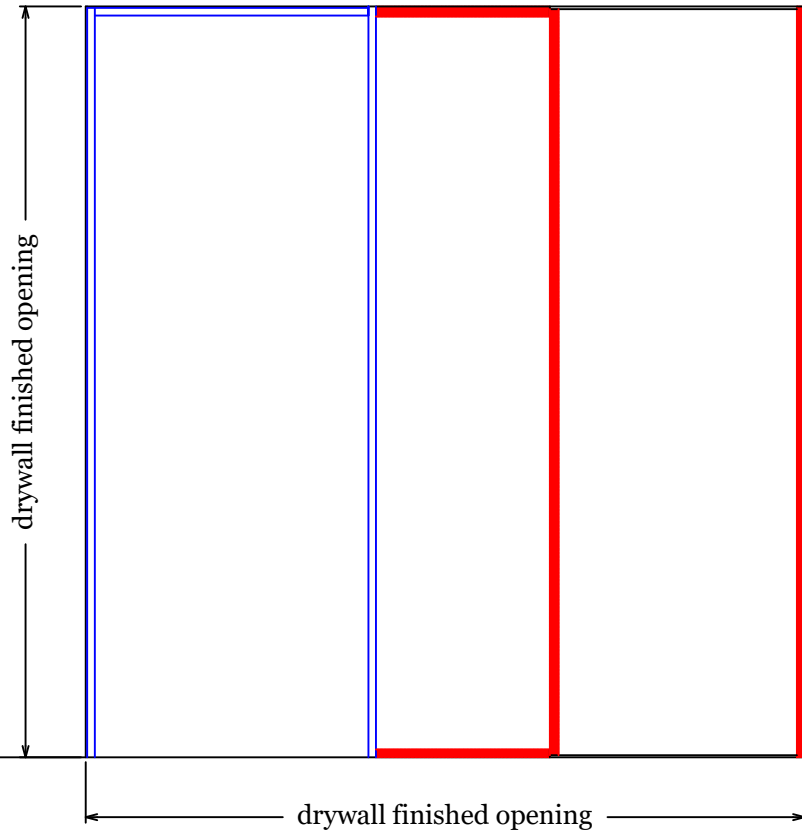

**Step 8-INT:**

Cut the 225-1 intermediate vertical glass jamb to length (from 225-7S wall start - floor to ceiling). Install with the provided clip top and bottom.

Proceed to cut and install the 225-6 & 225-3 glazing components at the top and bottom of the opening.

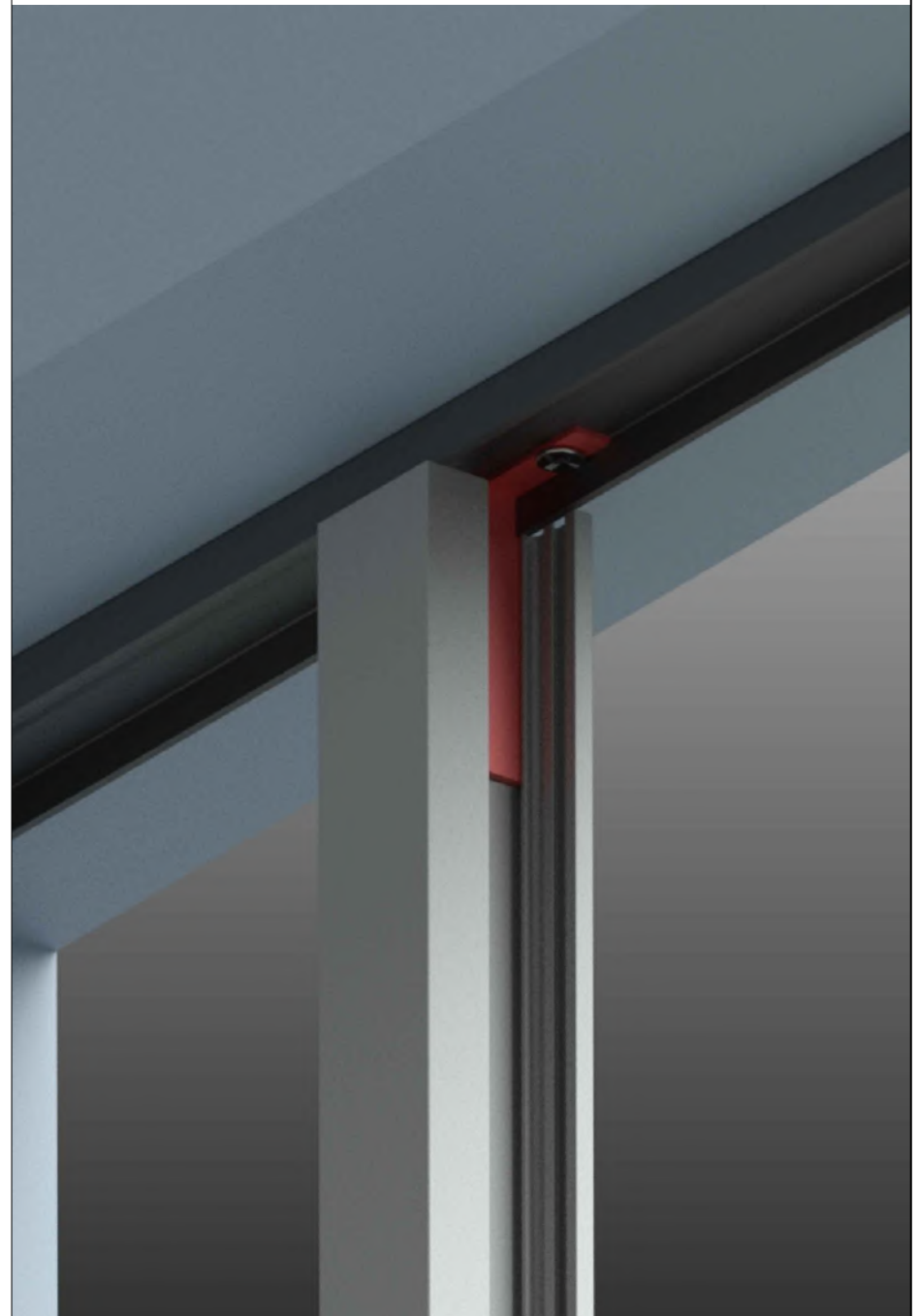

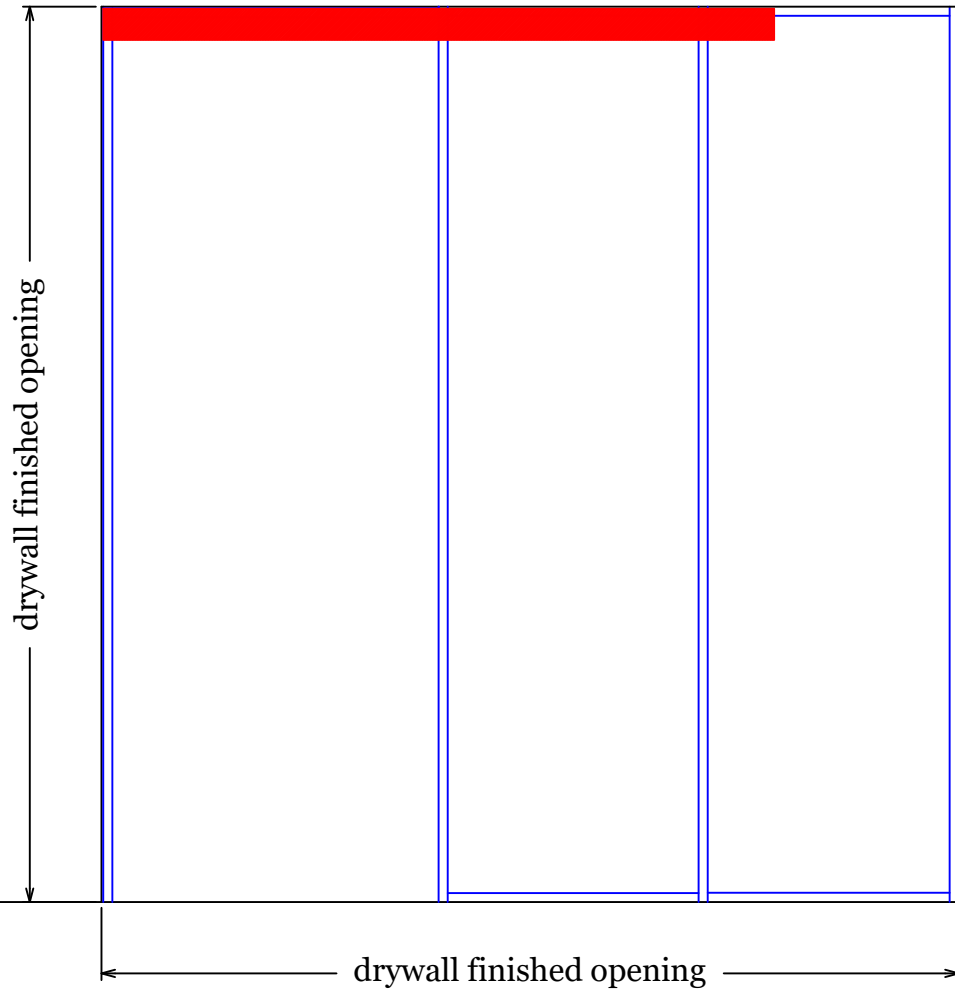

**Step 9:**  
Install the vertical trim (2 pcs of 100 trim and 2 pcs of 100-WDT trim) on the cased opening and then the 2 pcs of 100 trim at the header.

Install the barn door track (track is cut a factory to correct length)

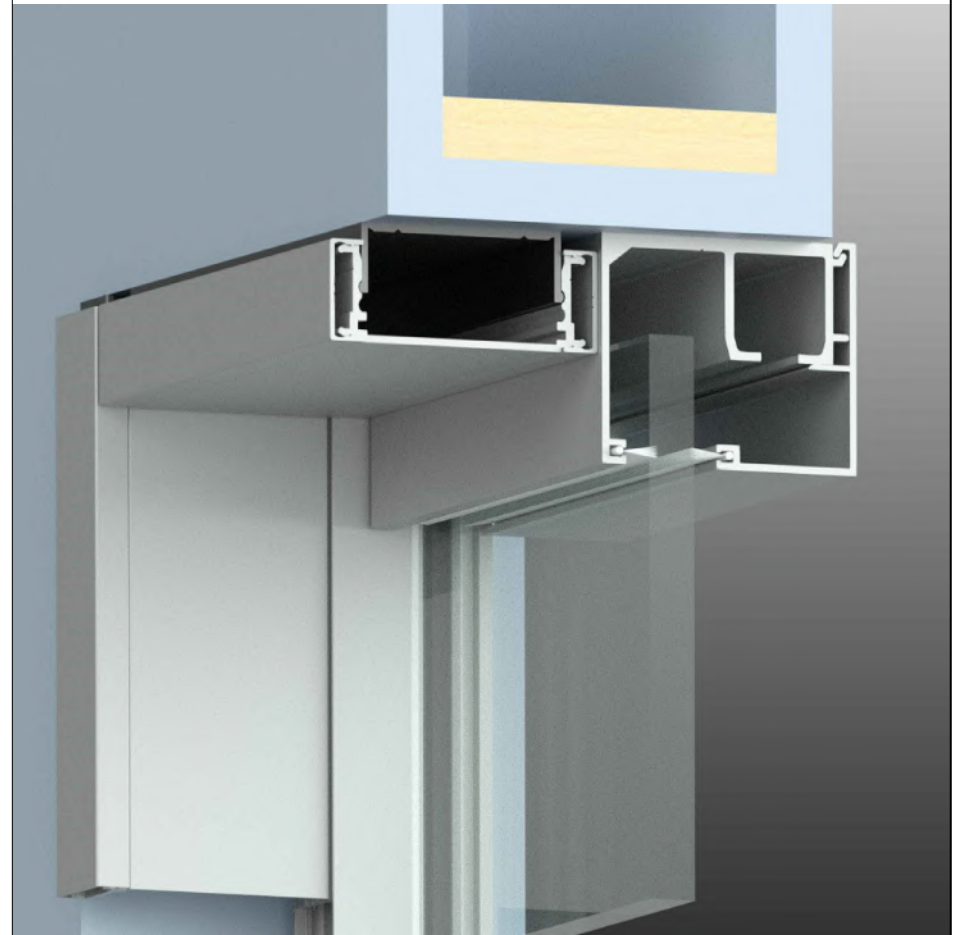

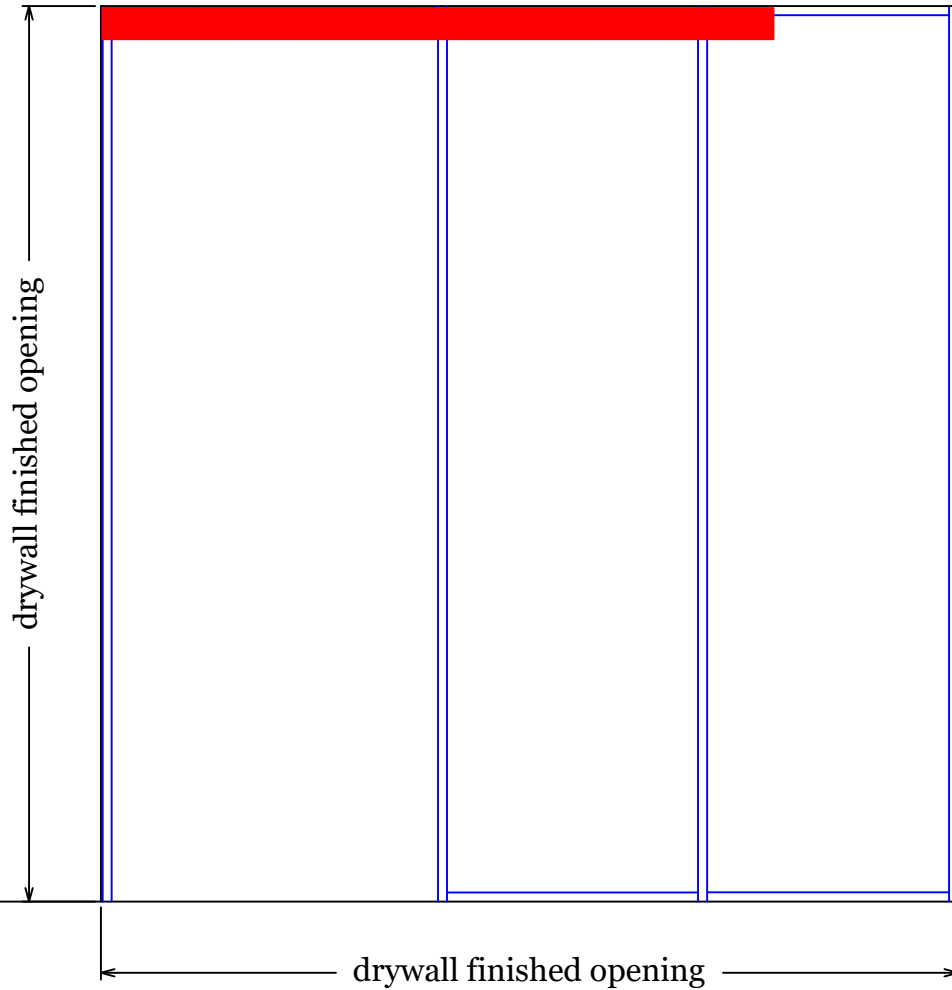

**Step 10:**  
Install the 1" trim around the cased opening frame and then install the barn door sliding track.  
Track will be cut to length at the factory.

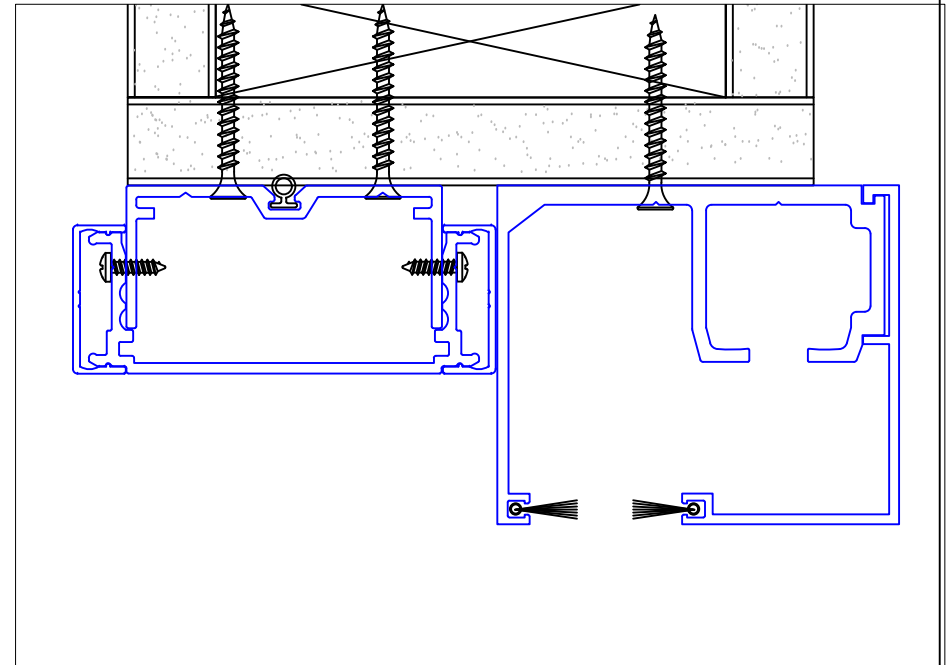
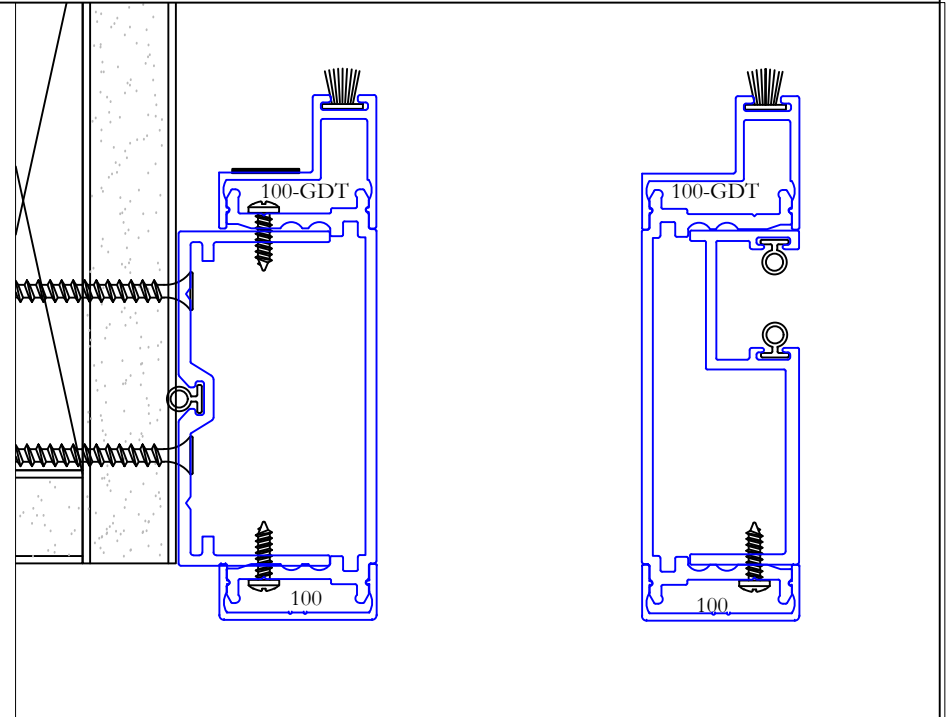

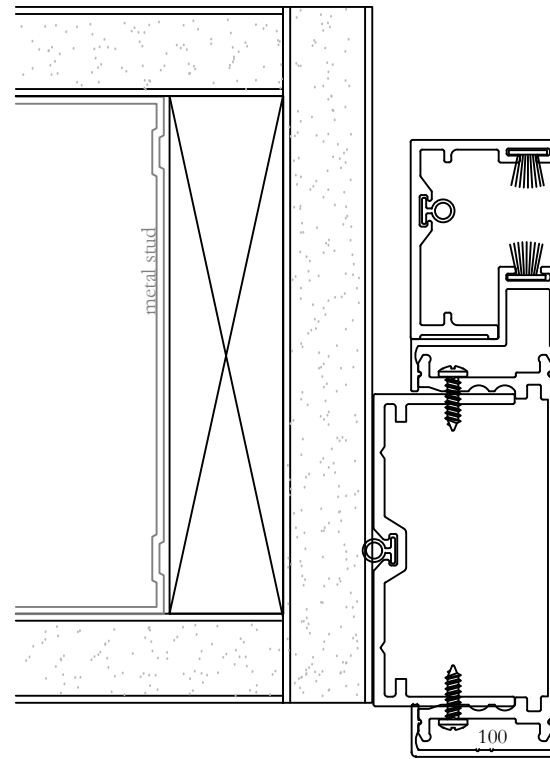
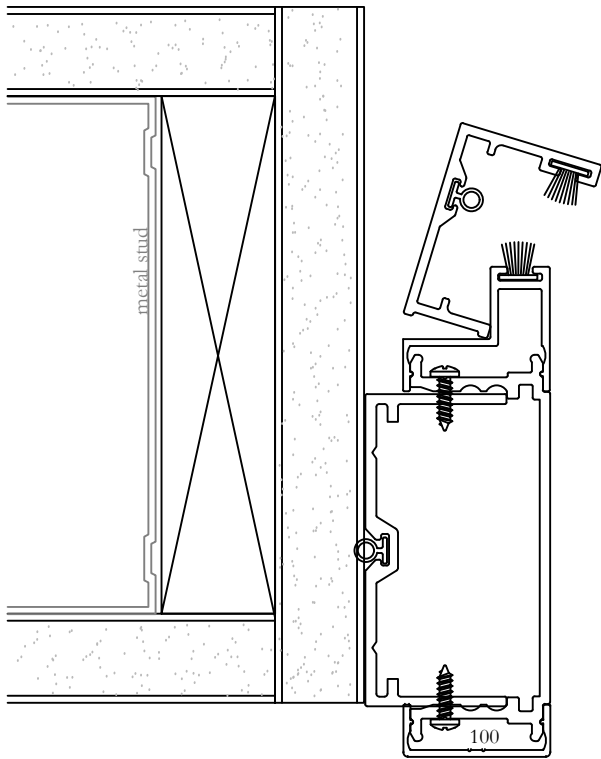

**Step 11:**

Install door receiving channel to the trim with the factory supplied VHB 3M tape. This receiving channel should be cut from the floor to the ceiling. Install the channel by placing the leading edge to the trim and rotate the trim to engage the tape.

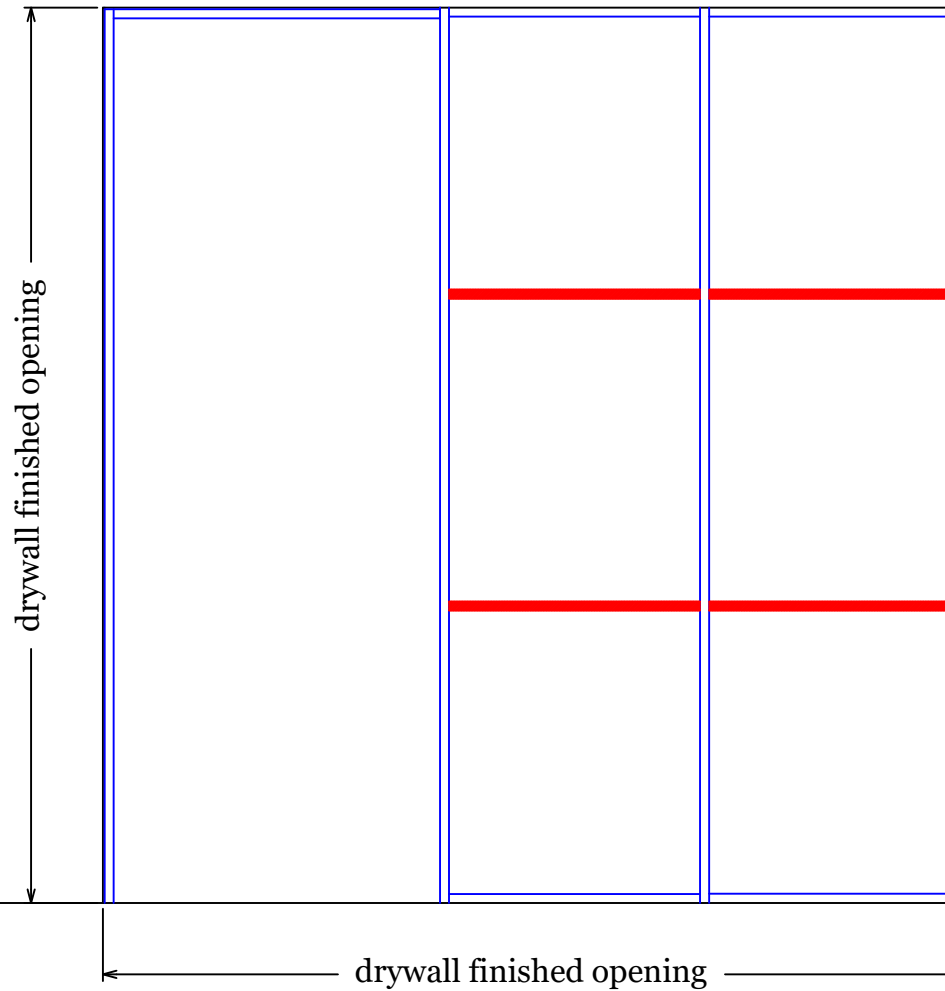

**Step 12:**

After installation of glass, cut the horizontal trim to length and apply directly to glass on each side. (trim has factory applied double sided tape)